

**canfield connector**  
8510 Foxwood Court  
Youngstown, Ohio 44514  
(330) 758-8299 Fax: (330) 758-8912  
www.canfieldconnector.com

## SERIES 9E

## REED & ELECTRONIC SENSORS FOR UNIVERSAL APPLICATIONS

### General Description

The Canfield Connector Series 9E is a universal, ultra-small, magnetic proximity switch available in both solid state electronic and reed styles. These sensors are designed to fit the most stringent space requirements by use of a standard .250 inch dovetail slot. Many other mounting options are also available. The electronic sensor exhibits greater sensitivity to magnetism with reduced dead-band and hysteresis as compared to competitive devices. The reed sensor offers a wide operating voltage range. The molded switch has an on board indicator light that can be viewed from wide angles. Standard connection to the sensor is provided by a 9 ft. PVC or 8mm quick connect male pigtail. The rugged, fully encapsulated switch is shipped with mounting hardware ready for installation.

### Dimensional Data

ALL DIMENSIONS ARE IN MILLIMETERS UNLESS OTHERWISE NOTED

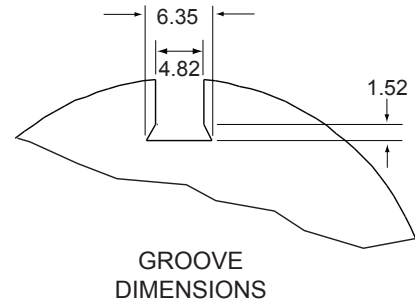
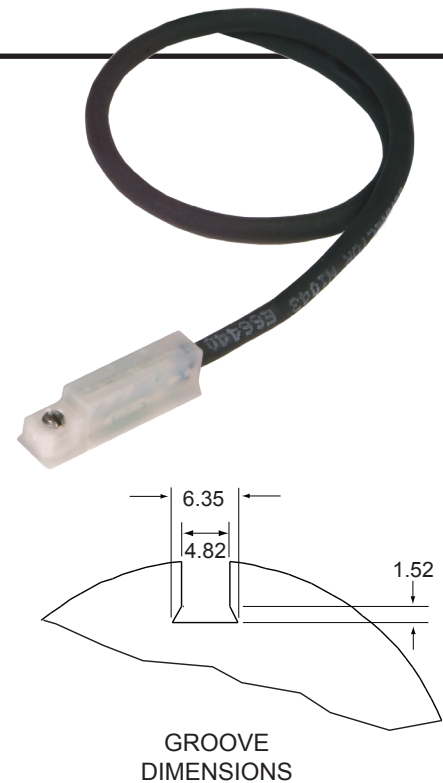
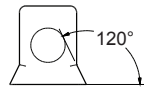
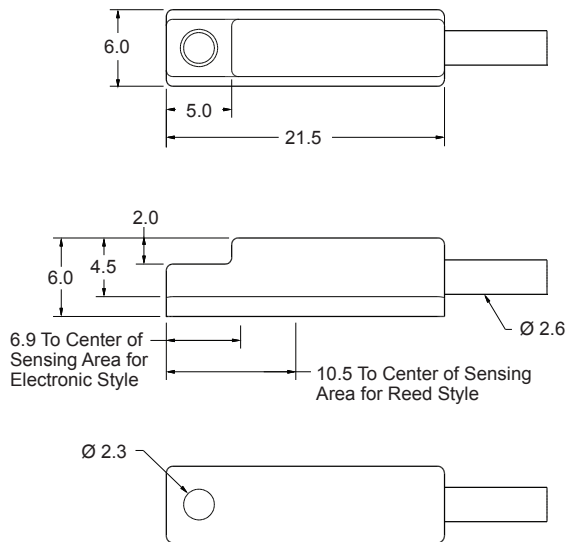

### Technical Data

- Material: Nylon, TPU and PVC
- Temperature Range: Operational from -20° to +80°C
- Shock: Operational up to 30G (11 ms.) reeds only. Not applicable for electronic.
- Vibration: Operational up to 20G (10 - 55 Hz) reeds only. Not applicable for electronic.
- Sensitivity and Orientation: 85 gauss parallel (standard for reeds)  
25 gauss parallel (standard for electronic)

### Features

- Small sensor fits most space requirements.
- Stand-alone mounting into any 1/4" dovetail slot (machined or extruded)
- Other special mounting clamp styles available
- Indicator light
- Corrosion and washdown resistant.
- Electronic sensing version (no moving parts)
- Reverse polarity protection
- DC or AC voltage versions
- Compatible with IS (Intrinsically Safe) barriers
- Available for dovetail, round, tie-rod and rodless cylinder mountings.

**Style 0**

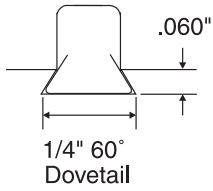

**Style 1**

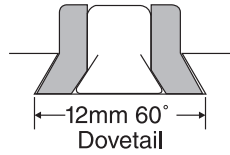

**Style 2**

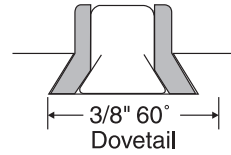

**Style 3**

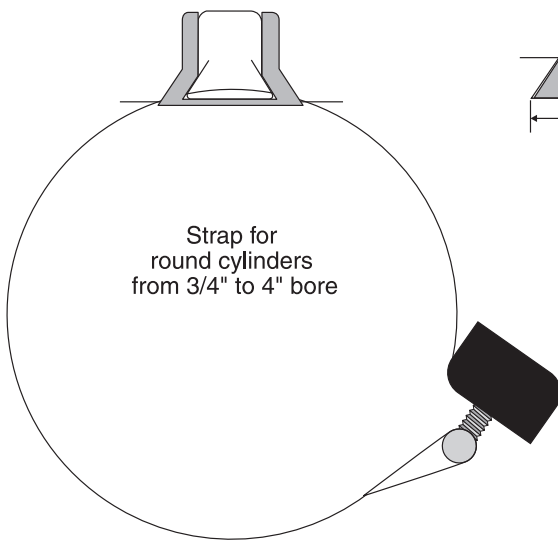

**Style 4**

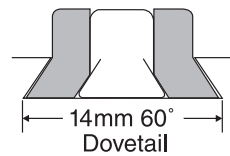

**Style F**

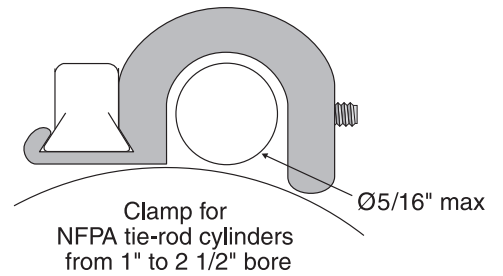

**Style G**

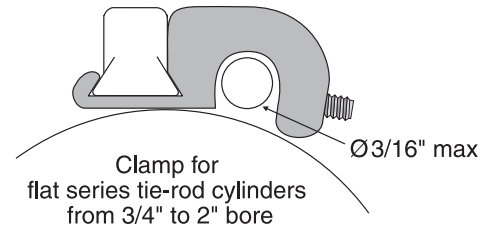

**Style J**

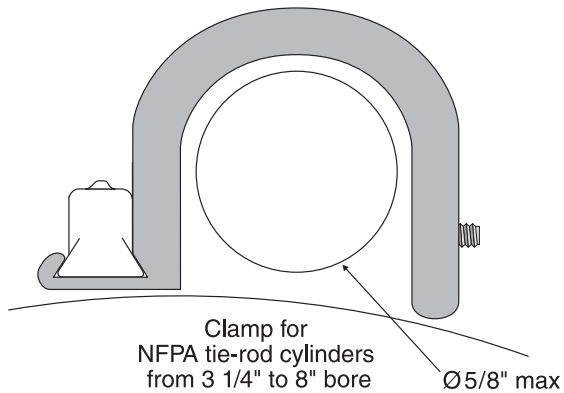

**Style H**

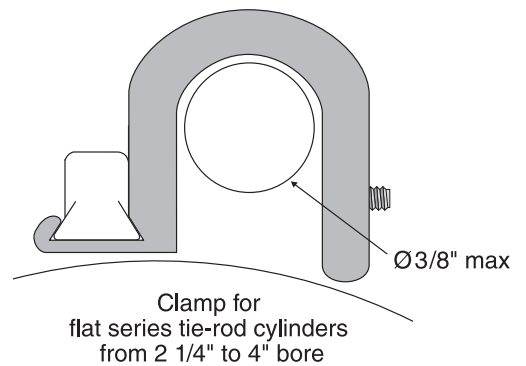

## Ordering Information

9 E 1 0 -  0 0 -

### Mounting Styles

- 0 - 1/4" 60° dovetail (standard)
- 1 - 12mm 60° dovetail adapter
- 2 - 3/8" 60° dovetail adapter
- 3 - Round cylinder clamp 3/4" - 4" bore
- 4 - 14mm 60° dovetail adapter
- F - NFPA tie-rod cylinder clamp 1" - 2 1/2" bore
- G - Flat series cylinder clamp 3/4" - 2" bore
- H - Flat series cylinder clamp 2 1/4" - 4" bore
- J - NFPA tie-rod cylinder clamp 3 1/4" - 8" bore

### Connection Options

- 0 - 9 ft PVC cable
- 3 - 8mm quick connect male pigtail\*

\*Mates with cordsets shown at right.

### Mating Cordsets

8mm female molded locking connectors

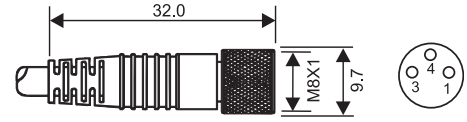

Order part number

Brown = Pin 1  
Blue = Pin 3  
Black = Pin 4

RC08S-F0M030120 (2m length)  
RC08S-F0M030150 (5m length)

Type	Description	Function	Switching Voltage	Switching Current	Switching Power	Switching Speed	Voltage Drop	Magnetic Sensitivity
01	Reed Switch	Normally Open SPST	0 - 120V AC/DC 50/60 Hz	0.25 Amps Max.	5 watts Max.	0.4 ms operate 0.1 ms release	0 Volts	85 Ga.
02	Reed Switch for PLC's, LED (current limiting)	Normally Open SPST	5 - 120V AC/DC 50/60 Hz	0.03 Amps Max. 0.001 Amps Min.	4 watts Max.	0.4 ms operate 0.1 ms release	3.5 Volts @ 5mA	85 Ga.
31	Electronic for Reed Magnet, LED & Sourcing	Normally Open PNP	5 - 28 VDC	0.2 Amps Max.	4.8 watts Max.	4 μs operate 4 μs release	1.0 Volts	25 Ga.
32	Electronic for Reed Magnet, LED & Sinking	Normally Open NPN	5 - 28 VDC	0.2 Amps Max.	4.8 watts Max.	4 μs operate 4 μs release	1.0 Volts	25 Ga.



### SERIES 9E

Can-Pak Part Number	Qty	Function Normally Open	Switch Type
CP-9E10-000-002-010	10	SPST	Reed
CP-9E10-000-031-010	10	PNP	Electronic
CP-9E10-000-032-010	10	NPN	Electronic
CP-9E10-000-302-010	10	SPST	Reed
CP-9E10-000-331-010	10	PNP	Electronic
CP-9E10-000-332-010	10	NPN	Electronic

### Ordering Example:

9E10-000-002

1/4" dovetail, 9 ft. PVC cable, reed switch for PLC's with LED, SPST, normally open, 5 - 120V AC/DC 50/60 Hz