

canfield connector
8510 Foxwood Court
Youngstown, Ohio 44514
(330) 758-8299 Fax: (330) 758-8912
www.canfieldconnector.com

SERIES 9D

REED & ELECTRONIC SENSORS FOR UNIVERSAL APPLICATIONS

General Description

The Canfield Connector Series 9D is a universal, ultra-small, magnetic proximity switch available in both solid state electronic and reed styles. These sensors are designed to fit the most stringent space requirements by use of a standard .250 inch dovetail slot. Many other mounting options are also available. The electronic sensor exhibits greater sensitivity to magnetism with reduced dead-band and hysteresis as compared to competitive devices. The reed sensor offers a wide operating voltage range. The molded switch has an on board indicator light that can be viewed from wide angles. Standard connection to the sensor is provided by a 9 ft. PVC or 8mm quick connect male pigtail. The rugged, fully encapsulated switch is shipped with mounting hardware ready for installation.

Dimensional Data

ALL DIMENSIONS ARE IN MILLIMETERS UNLESS OTHERWISE NOTED

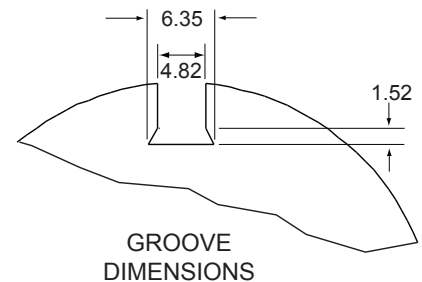
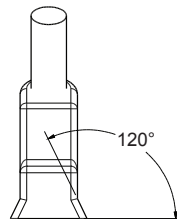
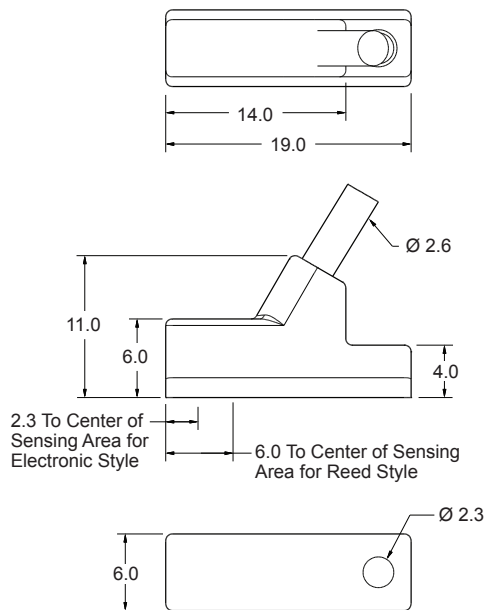

Technical Data

- Material: Nylon, TPU and PVC
- Temperature Range: Operational from -20° to +80°C
- Shock: Operational up to 30G (11 ms.) reeds only. Not applicable for electronic.
- Vibration: Operational up to 20G (10 - 55 Hz) reeds only. Not applicable for electronic.
- Sensitivity and Orientation: 85 gauss parallel (standard for reeds)
25 gauss parallel (standard for electronic)

Features

- Small sensor fits most space requirements.
- Stand-alone mounting into any 1/4" dovetail slot (machined or extruded)
- Other special mounting clamp styles available
- Indicator light
- Corrosion and washdown resistant.
- Electronic sensing version (no moving parts)
- 60° wire outlet for close mounting
- Reverse polarity protection
- DC or AC voltage versions
- Compatible with IS (Intrinsically Safe) barriers
- Available for dovetail, round, tie-rod and rodless cylinder mountings.

Style 0

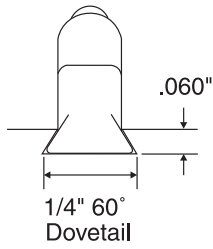

Style 1

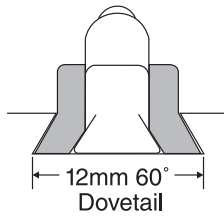

Style 2

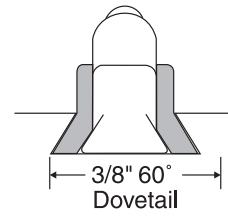

Style 3

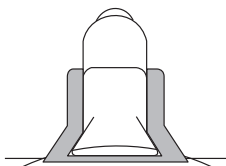

Style 4

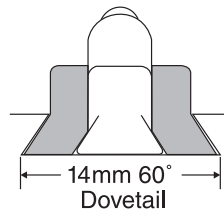

Style F

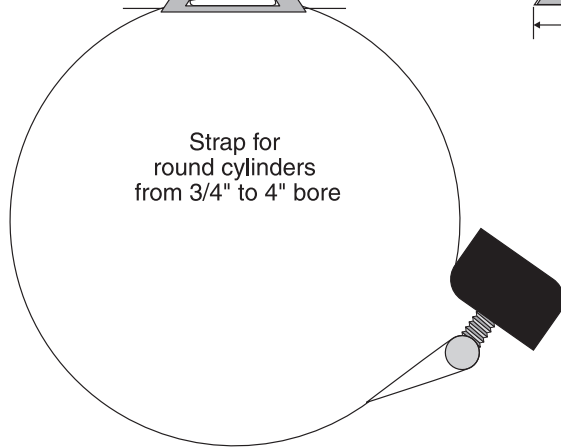
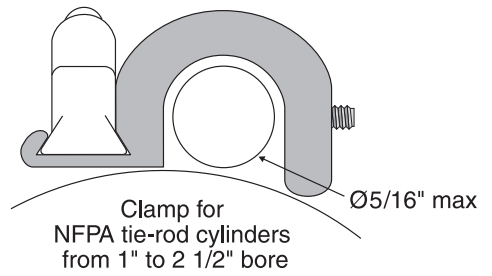

Style G

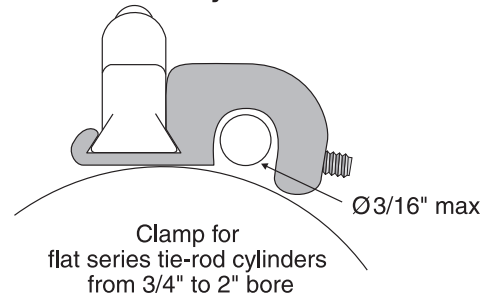

Style J

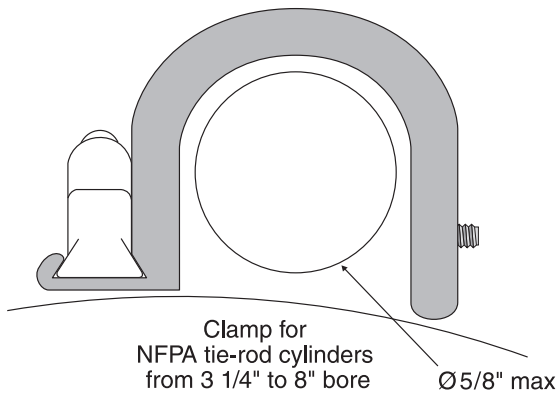

Style H

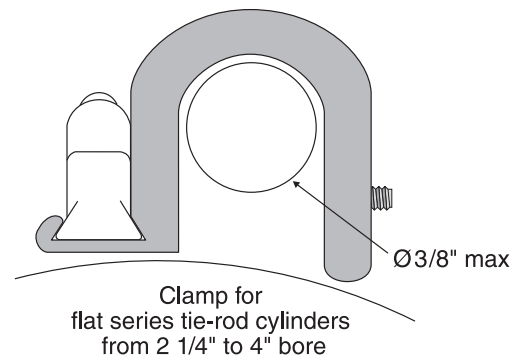

Ordering Information

9 D 1 0 - 0 0 -

Mounting Styles

- 0 - 1/4" 60° dovetail (standard)
- 1 - 12mm 60° dovetail adapter
- 2 - 3/8" 60° dovetail adapter
- 3 - Round cylinder clamp 3/4" - 4" bore
- 4 - 14mm 60° dovetail adapter
- F - NFPA tie-rod cylinder clamp 1" - 2 1/2" bore
- G - Flat series cylinder clamp 3/4" - 2" bore
- H - Flat series cylinder clamp 2 1/4" - 4" bore
- J - NFPA tie-rod cylinder clamp 3 1/4" - 8" bore

Connection Options

- 0 - 9 ft PVC cable
- 3 - 8mm quick connect male pigtail*

*Mates with cordsets shown at right.

Mating Cordsets

8mm female molded locking connectors

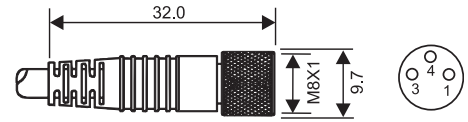

Order part number

Brown = Pin 1
Blue = Pin 3
Black = Pin 4

RC08S-F0M030120 (2m length)
RC08S-F0M030150 (5m length)

Type	Description	Function	Switching Voltage	Switching Current	Switching Power	Switching Speed	Voltage Drop	Magnetic Sensitivity
01	Reed Switch	Normally Open SPST	0 - 120V AC/DC 50/60 Hz	0.25 Amps Max.	5 watts Max.	0.4 ms operate 0.1 ms release	0 Volts	85 Ga.
02	Reed Switch for PLC's, LED (current limiting)	Normally Open SPST	5 - 120V AC/DC 50/60 Hz	0.03 Amps Max. 0.001 Amps Min.	4 watts Max.	0.4 ms operate 0.1 ms release	3.5 Volts @ 5mA	85 Ga.
31	Electronic for Reed Magnet, LED & Sourcing	Normally Open PNP	5 - 28 VDC	0.2 Amps Max.	4.8 watts Max.	4 µs operate 4 µs release	1.0 Volts	25 Ga.
32	Electronic for Reed Magnet, LED & Sinking	Normally Open NPN	5 - 28 VDC	0.2 Amps Max.	4.8 watts Max.	4 µs operate 4 µs release	1.0 Volts	25 Ga.



SERIES 9D

Can-Pak Part Number	Qty	Function Normally Open	Switch Type
CP-9D10-000-002-010	10	SPST	Reed
CP-9D10-000-031-010	10	PNP	Electronic
CP-9D10-000-032-010	10	NPN	Electronic
CP-9D10-000-302-010	10	SPST	Reed
CP-9D10-000-331-010	10	PNP	Electronic
CP-9D10-000-332-010	10	NPN	Electronic

Ordering Example:

9D10-000-002

1/4" dovetail, 9 ft. PVC cable, reed switch for PLC's with LED, SPST, normally open, 5 - 120V AC/DC 50/60 Hz